

Längsansicht 1:5

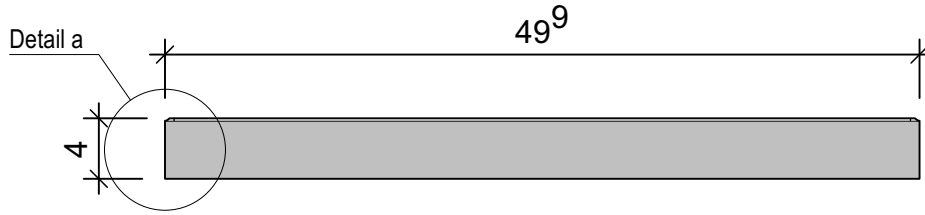

Grundriss 1:5

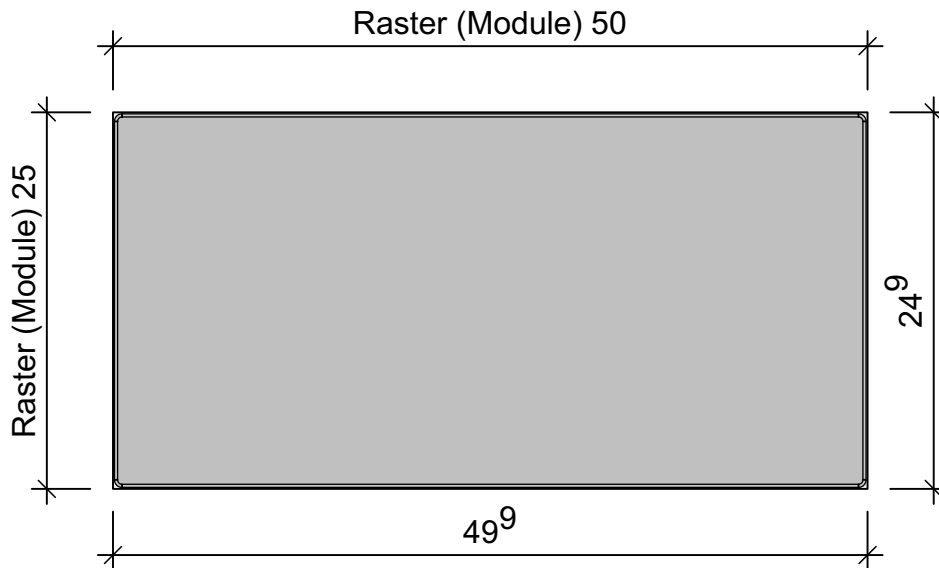

Detail a 1:1

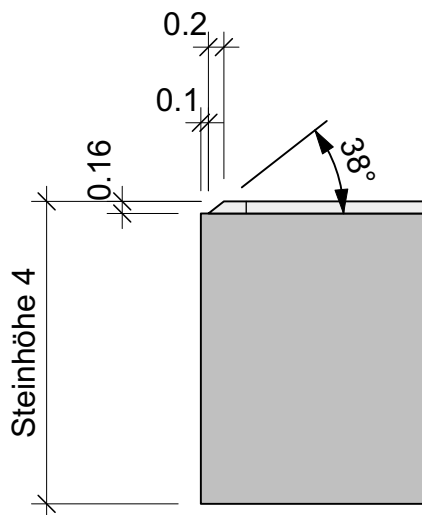

m ³	kg
0.005	12

alle Masse in cm!

		Oberneuhofstrasse 5 6341 Baar		Tel. +41 41 769 59 59 www.tschuemperlin-ag.ch		Art.-Nr.: 40.100.4041	
Bezeichnung: Gehwegplatte 25 x 50 x 4cm				Artikelgruppe / Plan-Nr.: 401010 - 001		Index -	
Änd.	Datum	Name	Beschreibung	gez.:	zeb	Dat.: 15.01.2024	
-	-	-	-	gepr.:	ser	Dat.: -	
-	-	-	-	freigegeben	rue / ser	Dat.: -	
-	-	-	-	Ersatz für	-	Format A4	Massstab 1:5
-	-	-	-	Beton	Rezept R101 / R104		
-	-	-	-	Betonvorsatz	Rezept		